

Αναγράψτε στο τέλος του κωδικού των εξαρτημάτων, τον τύπο της σχάρας (Α ή Β ή C).
Write at the end of the code of the accessories, the type of the cable tray (A or B or C).

ΠΛΑΤΟΣ WIDTH	ΠΑΧΟΣ THICKNESS	ΚΩΔΙΚΟΣ CODE	
(mm)	(mm)	ΤΑΦ ΤΕΕ	ΚΑΠΑΚΙ COVER
100	0,80	FTE.0100.085.080	FTEC.0100.080
	1,00	FTE.0100.085.100	FTEC.0100.100
	1,50	FTE.0100.085.150	FTEC.0100.150

ΠΛΑΤΟΣ WIDTH	ΠΑΧΟΣ THICKNESS	ΚΩΔΙΚΟΣ CODE	
(mm)	(mm)	ΤΑΦ ΤΕΕ	ΚΑΠΑΚΙ COVER
400	0,80	FTE.0400.085.080	FTEC.0400.080
	1,00	FTE.0400.085.100	FTEC.0400.100
	1,50	FTE.0400.085.150	FTEC.0400.150

150	0,80	FTE.0150.085.080	FTEC.0150.080
	1,00	FTE.0150.085.100	FTEC.0150.100
	1,50	FTE.0150.085.150	FTEC.0150.150

500	0,80	FTE.0500.085.080	FTEC.0500.080
	1,00	FTE.0500.085.100	FTEC.0500.100
	1,50	FTE.0500.085.150	FTEC.0500.150

200	0,80	FTE.0200.085.080	FTEC.0200.080
	1,00	FTE.0200.085.100	FTEC.0200.100
	1,50	FTE.0200.085.150	FTEC.0200.150

600	0,80	FTE.0600.085.080	FTEC.0600.080
	1,00	FTE.0600.085.100	FTEC.0600.100
	1,50	FTE.0600.085.150	FTEC.0600.150

300	0,80	FTE.0300.085.080	FTEC.0300.080
	1,00	FTE.0300.085.100	FTEC.0300.100
	1,50	FTE.0300.085.150	FTEC.0300.150

- Κατόπιν ειδικής παραγγελίας κατασκευάζονται και ασύμμετρα.

- They can be manufactured asymmetrically made-to-order.

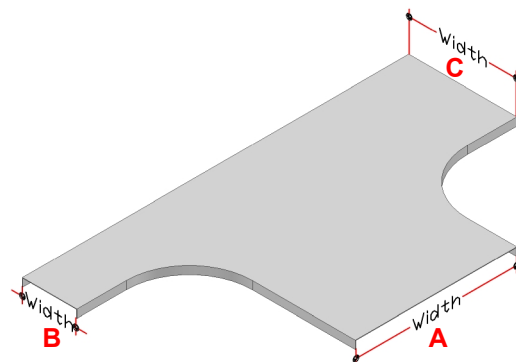
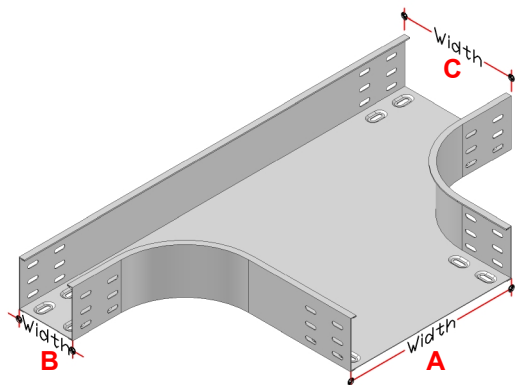

Προγαλβανισμένα προϊόντα. Ισχύουν οι παραπάνω κωδικοί.

Εν θερμώ γαλβανισμένα: Αναγράψτε στο τέλος του κωδικού το γράμμα D

Ανοξείδωτα προϊόντα: Αναγράψτε στο τέλος του κωδικού το γράμμα I.

Pre-galvanized products: Referenced, by the codes above.

Hot-Dip Galvanized: Write at the end of the code the letter D

Inox products: Write at the end of the code the letter I.