

Αναγράψτε στο τέλος του κωδικού των εξαρτημάτων, τον τύπο της σχάρας (Α ή Β ή C).  
 Write at the end of the code of the accessories, the type of the cable tray (A or B or C).

ΠΛΑΤΟΣ WIDTH	ΠΑΧΟΣ THICKNESS	ΚΩΔΙΚΟΣ CODE	
		90° ΕΣΩΤΕΡΙΚΗ 90° INTERNAL	ΚΑΠΑΚΙ ΚΑΠΑΚΙ
(mm)	(mm)		
50	0,80	FIE.0050.060.080	FIEC.0050.080
	1,00	FIE.0050.060.100	FIEC.0050.100
	1,50	FIE.0050.060.150	FIEC.0050.150

ΠΛΑΤΟΣ WIDTH	ΠΑΧΟΣ THICKNESS	ΚΩΔΙΚΟΣ CODE	
		90° ΕΣΩΤΕΡΙΚΗ 90° INTERNAL	ΚΑΠΑΚΙ ΚΑΠΑΚΙ
(mm)	(mm)		
300	0,80	FIE.0300.060.080	FIEC.0300.080
	1,00	FIE.0300.060.100	FIEC.0300.100
	1,50	FIE.0300.060.150	FIEC.0300.150

100	0,80	FIE.0100.060.080	FIEC.0100.080
	1,00	FIE.0100.060.100	FIEC.0100.100
	1,50	FIE.0100.060.150	FIEC.0100.150

400	0,80	FIE.0400.060.080	FIEC.0400.080
	1,00	FIE.0400.060.100	FIEC.0400.100
	1,50	FIE.0400.060.150	FIEC.0400.150

150	0,80	FIE.0150.060.080	FIEC.0150.080
	1,00	FIE.0150.060.100	FIEC.0150.100
	1,50	FIE.0150.060.150	FIEC.0150.150

500	0,80	FIE.0500.060.080	FIEC.0500.080
	1,00	FIE.0500.060.100	FIEC.0500.100
	1,50	FIE.0500.060.150	FIEC.0500.150

200	0,80	FIE.0200.060.080	FIEC.0200.080
	1,00	FIE.0200.060.100	FIEC.0200.100
	1,50	FIE.0200.060.150	FIEC.0200.150

600	0,80	FIE.0600.060.080	FIEC.0600.080
	1,00	FIE.0600.060.100	FIEC.0600.100
	1,50	FIE.0600.060.150	FIEC.0600.150

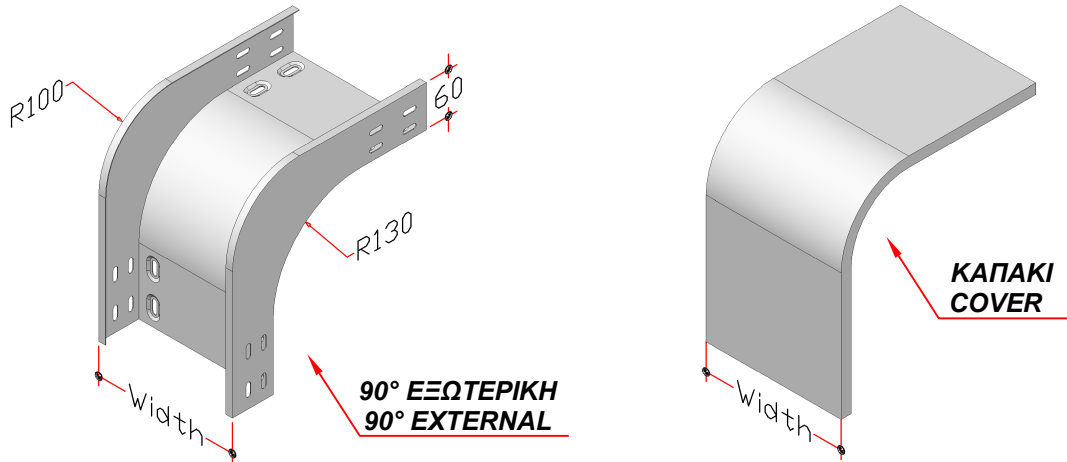

Αναγράψτε στο τέλος του κωδικού των εξαρτημάτων, τον τύπο της σχάρας (Α ή Β ή C).  
 Write at the end of the code of the accessories, the type of the cable tray (A or B or C).

ΠΛΑΤΟΣ WIDTH	ΠΑΧΟΣ THICKNESS	ΚΩΔΙΚΟΣ CODE	
		90° ΕΞΩΤΕΡΙΚΗ 90° EXTERNAL	ΚΑΠΑΚΙ COVER
(mm)	(mm)		
50	0,80	FEE.0050.060.080	FEEC.0050.080
	1,00	FEE.0050.060.100	FEEC.0050.100
	1,50	FEE.0050.060.150	FEEC.0050.150

ΠΛΑΤΟΣ WIDTH	ΠΑΧΟΣ THICKNESS	ΚΩΔΙΚΟΣ CODE	
		90° ΕΞΩΤΕΡΙΚΗ 90° EXTERNAL	ΚΑΠΑΚΙ COVER
(mm)	(mm)		
300	0,80	FEE.0300.060.080	FEEC.0300.080
	1,00	FEE.0300.060.100	FEEC.0300.100
	1,50	FEE.0300.060.150	FEEC.0300.150

100	0,80	FEE.0100.060.080	FEEC.0100.080
	1,00	FEE.0100.060.100	FEEC.0100.100
	1,50	FEE.0100.060.150	FEEC.0100.150

400	0,80	FEE.0400.060.080	FEEC.0400.080
	1,00	FEE.0400.060.100	FEEC.0400.100
	1,50	FEE.0400.060.150	FEEC.0400.150

150	0,80	FEE.0150.060.080	FEEC.0150.080
	1,00	FEE.0150.060.100	FEEC.0150.100
	1,50	FEE.0150.060.150	FEEC.0150.150

500	0,80	FEE.0500.060.080	FEEC.0500.080
	1,00	FEE.0500.060.100	FEEC.0500.100
	1,50	FEE.0500.060.150	FEEC.0500.150

200	0,80	FEE.0200.060.080	FEEC.0200.080
	1,00	FEE.0200.060.100	FEEC.0200.100
	1,50	FEE.0200.060.150	FEEC.0200.150

600	0,80	FEE.0600.060.080	FEEC.0600.080
	1,00	FEE.0600.060.100	FEEC.0600.100
	1,50	FEE.0600.060.150	FEEC.0600.150